

MEITRACK MVT100 User Guide



Change History



File Name	MEITRACK MVT100 User Guide	Created By	Renny Lee
Project	MVT100	Creation Date	2010-08-30
		Update Date	2016-04-07
Subproject	User Guide	Total Pages	13
Version	V5.3	Confidential	External Documentation

Contents

1 Copyright and Disclaimer	- 4 -
2 Product Overview	- 4 -
3 Product Function and Specifications	- 4 -
3.1 Product Function	- 4 -
3.1.1 Position Tracking	- 4 -
3.1.2 Anti-Theft	- 4 -
3.1.3 Other Functions	- 4 -
3.2 Specifications	- 5 -
4 MVT100 and Accessories	- 5 -
5 Appearance	- 6 -
6 First Use	- 6 -
6.1 Installing the SIM Card	- 6 -
6.2 Charging	- 6 -
6.3 LED Indicator	- 7 -
6.4 Configured by Computer	- 7 -
6.5 Tracking by Mobile Phone	- 7 -
6.6 Common SMS Commands	- 9 -
6.6.1 Setting a Combined Function Phone Number – A71	- 9 -
6.6.2 Setting the Smart Sleep Mode – A73	- 9 -
7 MS03 Tracking System	- 10 -
8 Installing the MVT100	- 10 -
8.1 Installing an I/O Cable	- 10 -
8.2 Wiring Diagram	- 11 -
8.2.1 Power Cable/Ground Wire (Pin 1/2)	- 11 -
8.2.2 Digital Input 1 (Pin 4, Negative Trigger/SOS Button)	- 12 -
8.2.3 Digital Input 2 (Pin 5, Positive Trigger)	- 12 -
8.2.4 Output (Pin 7)	- 12 -
8.2.5 Voltage Formula for the Built-in Battery and External Power Supply	- 12 -
8.2.6 Analog Input (Pin 6)	- 12 -
8.3 Mounting the MVT100	- 12 -

1 Copyright and Disclaimer

Copyright © 2016 MEITRACK. All rights reserved.

 and  are trademarks that belong to Meitrack Group.

The user manual may be changed without notice.

Without prior written consent of Meitrack Group, this user manual, or any part thereof, may not be reproduced for any purpose whatsoever, or transmitted in any form, either electronically or mechanically, including photocopying and recording.

Meitrack Group shall not be liable for direct, indirect, special, incidental, or consequential damages (including but not limited to economic losses, personal injuries, and loss of assets and property) caused by the use, inability, or illegality to use the product or documentation.

2 Product Overview

The MVT100 is a vehicle tracker that can be used in cars, motorcycles, yachts, and boats. The MVT100's unique design makes its appearance cool. The product is easy to install, water resistant (IP66), dustproof, and has built-in antenna. Once installed on a vehicle, the MVT100 is hard to be noticed. Under typhoon or rainstorm condition, the MVT100 can still work properly.

3 Product Function and Specifications

3.1 Product Function

3.1.1 Position Tracking

- GPS + GSM dual-module tracking
- Real-time location query
- Track by time interval
- Track by distance
- Track by mobile phone
- Speeding alarm
- Heading change report

3.1.2 Anti-Theft

- SOS alarm
- Polygon geo-fence
- External power supply cut-off alarm
- GPS blind spot alarm
- Low power alarm
- Remote vehicle fuel/power cut-off alarm
- Towing alarm
- Engine or vehicle door status alarm

3.1.3 Other Functions

- SMS/GPRS (TCP/UDP) communication (Meitrack protocol)

- Built-in 8 MB buffer for recording driving routes
- Water resistant (IP66)
- Mileage report
- Support Over-the-Air (OTA)
- Built-in standby battery
- Smart power saving mode

3.2 Specifications

Item	Specifications
Dimension	110 mm x 72 mm x 39 mm
Weight	170g
Input voltage	DC 11 V to 36 V/1.5 A
Standby battery	850 mAh/3.7 V
Power consumption	65 mA standby current
Operating temperature	-20°C to 55°C
Operating humidity	5% to 95%
Working hour	43 hours in power-saving mode and 10 hours in normal mode
LED indicator	2 indicators showing GSM and GPS status
Button/Switch	1 SOS button (for sending SMSs) 1 power button (next to the SIM card slot)
Memory	8 MB byte
Sensor	3D acceleration sensor (for wake-up by vibration and towing alarms)
GSM frequency band	GSM 850/900/1800/1900 MHz
GPS sensitivity	-161 dB
Positioning accuracy	10m
Antenna	Built-in GSM and GPS antennas
I/O port	2 inputs (1 negative input and 1 positive input) 1 analog detection input 1 output 1 USB port

4 MVT100 and Accessories

MVT100 and standard accessories:



MVT100 with a battery, I/O cable, and SOS button



3M sticker



Screws



USB cable



CD

5 Appearance



6 First Use

6.1 Installing the SIM Card

To install the SIM card, perform the following operations:

1. Loosen the screws, and remove the cover.
2. Insert the SIM card into the card slot with its gold-plated contacts facing towards the Printed Circuit Board (PCB).
3. Close the cover, and tighten the screws.

Note:

- Ensure that the SIM card has sufficient balance.
- Ensure that the phone card PIN lock has been closed properly.
- Ensure that the SIM card in the MVT100 has subscribed the caller ID service if you want to use your authorized phone number to call the MVT100.
- Power off the MVT100 before installing the SIM card.

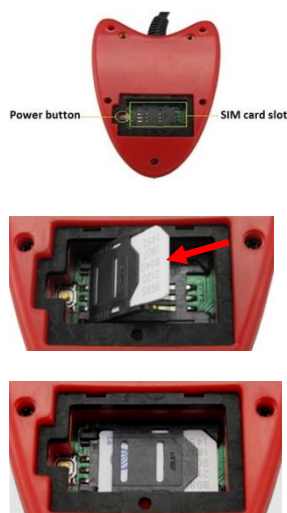

6.2 Charging

When you use the MVT100 for the first time, connect the MVT100 GND (-Black) and Power (+Red) wires to 12 V or 24 V external power supply for charging. Ensure that the MVT100 is charged at least three hours. Eight hours are recommended.

The MVT100 can be installed on a vehicle only after it is configured and tested.

6.3 LED Indicator

To start the MVT100, press and hold down the power button for 3s to 5s, or connect the MVT100 to external power supply (11 V to 36 V).

GPS Indicator (Blue)	
Steady on	One button is pressed or one input is activated.
Blink (every 0.1s)	The MVT100 is being initialized or the battery power is low.
Blink (0.1s on and 2.9s off)	A GPS signal is received.
Blink (1s on and 2s off)	No GPS signal is received.
GSM Indicator (Green)	
Steady on	A call is coming in or a call is being made.
Blink (every 0.1s)	The MVT100 is being initialized.
Blink (0.1s on and 2.9s off)	A GSM signal is received.
Blink (1s on and 2s off)	No GSM signal is received.

6.4 Configured by Computer

This section describes how to use Meitrack Manager to configure the MVT100 on a computer.

Procedure:

1. Install the USB-to-serial cable driver and Meitrack Manager.
2. Connect the MVT100 to a PC by using the USB-to-serial cable.



3. Run Meitrack Manager, then the following dialog box will appear:



Turn on the device, then Meitrack Manager will detect the device model automatically and the parameter page will appear accordingly.

For details about Meitrack Manager, see the *MEITRACK Manager User Guide*.

6.5 Tracking by Mobile Phone

Call or send the **0000,A00** command by SMS to the MVT100 SIM card number. The device will reply an SMS with a map link. Click the SMS link. The location will be displayed on Google Maps on your mobile phone.

Note: Ensure that the MVT100 SIM card number has subscribed the caller ID service. Otherwise, the caller ID will be blocked.



SMS example:

Now,061314 10:36,V,26,0Km/h,96%,http://maps.meigps.com/?lat=22.513781&lng=114.057183

The following table describes the SMS format:

Parameter	Description	Remarks
Now	Indicates the current location.	SMS header: indicates the alarm type.
061314 10:36	Indicates the date and time in MMDDYY hh:mm format.	None
V	The GPS is invalid.	A = Valid V = Invalid
26	Indicates the GSM signal strength.	Value: 1–32 The larger the value is, the stronger the signal is. If the value is greater than 12, GPRS reaches the normal level.
0Km/h	Indicates the speed.	Unit: km/h
96%	Indicates the remaining battery power.	None
http://maps.meigps.com/?lat=22.513781&lng=114.057183	This is a map link. Latitude: 22.513781 Longitude: 114.057183	None

If your mobile phone does not support HTTP, enter the latitude and longitude on Google Maps to query a location.



6.6 Common SMS Commands

6.6.1 Setting a Combined Function Phone Number – A71

SMS sending: 0000,A71,*Phone number 1,Phone number 2,Phone number 3*

SMS Reply: IMEI,A71,OK

Description:

Phone number: A phone number has a maximum of 16 bytes. If no phone numbers are set, leave them blank. Phone numbers are empty by default.

Phone number 1/2/3: SOS phone numbers. When you call the tracker by using these phone numbers, the tracker will reply an SMS with the location and send geo-fence alarms and low power alarms.

If all combined function phone numbers need to be deleted, send **0000,A71**.

When the SOS button is pressed, the tracker dials phone numbers 1, 2, and 3 in sequence. The tracker stops dialing when a phone number responds.

Example: 0000,A71,13811111111,13822222222,13833333333

Reply: 353358017784062,A71,OK

6.6.2 Setting the Smart Sleep Mode – A73

SMS sending: 0000,A73,*Sleep level*

SMS Reply: IMEI,A73,OK

Description:

When the sleep level is **0** (default value), disable the sleep mode.

When the sleep level is **1**, the tracker enters the normal sleep mode. The GSM module always works, and the GPS module occasionally enters the sleep mode. The tracker works 25% longer in the normal sleep mode than that in the normal working mode. This mode is not recommended for short interval tracking; this will affect the route precision.

When the sleep level is **2**, the tracker enters deep sleep mode. If no event (SOS, button changes, incoming calls, SMSs, or vibration) is triggered after five minutes, the GPS module will stop, and the GSM module will enter sleep mode. Once an event is triggered, the GPS and GSM modules will be woken up.

Note: In any condition, you can use an SMS command to disable the sleep mode, and then the tracker exits the sleep mode and returns back to the normal working mode.

Example: 0000,A73,2

Reply: 353358017784062,A73,OK

For details about SMS commands, see the *MEITRACK SMS Protocol*.

Note:

1. The default SMS command password is **0000**. You can change the password by using Meitrack Manager and SMS commands.
2. The device can be configured by SMS commands with a correct password. After an authorized phone number is set, only the authorized phone number can receive the preset SMS event report.

7 MS03 Tracking System

Visit <http://ms03.trackingmate.com>, enter the user name and password, and log in to the MS03. (Purchase the login account from your provider.)

For more information about how to add a tracker, see the *MEITRACK GPS Tracking System MS03 User Guide* (chapter 4 "Getting Started").

The MS03 supports the following functions:

- Track by time interval or distance.
- Query historical traces.
- Set polygon geo-fences.
- Bind driver and vehicle information.
- View various reports.
- Send commands in batches.
- Support OTA updates.

For details, see the *MEITRACK GPS Tracking System MS03 User Guide*.

8 Installing the MVT100

8.1 Installing an I/O Cable

The I/O cable is an 8-pin cable, including the power, analog input, negative input, and output.



1	2	3	4	5	6	7	8	9	10
Power (+)	GND (-)	GND (-)	Input 1 (-)	Input 2 (+)	AD 1	Output 1	USB port		

Pin	Color	Description
1 (Power +)	Red	Positive electrode of the power input, connected to the positive electrode of the vehicle storage battery. Input voltage: 11 V to 36 V. 12 V is recommended.

2 (GND)	Black	Ground wire, connected to the negative electrode of the vehicle storage battery or to the negative terminal.
3 (GND)	Black	Ground wire It can be used as a ground wire connected to an analog sensor.
4 (Input 1)	White	Digital input, negative trigger SOS button by default, used for asking for help When the SOS function is not required, input 1 connects to a door trigger signal cable to detect vehicle door status. (Most Chinese, Korean, and Japanese cars are negative edge-triggered.)
5 (Input 2)	Purple	Digital input, positive trigger Connect to the vehicle ACC cable by default to detect the vehicle ACC status. Connect to a door trigger signal cable to detect vehicle door status. (Most Europe and American cars are positive edge-triggered.)
6 (AD)	Blue	Analog input with 12-bit resolution and valid voltage 0–6.6 V Connect to an external sensor, such as the fuel sensor.
7 (Output)	Yellow	Valid: low level (0 V) Invalid: open drain Maximum voltage for output open drain (invalid): 45 V Maximum current for output low voltage: 500 mA Connect to an external relay to remotely cut off the vehicle fuel cable or engine power supply.
8/9/10 USB port (for configuration)	Green	TTL232 receiving (MVT100 sending)
	Orange	TTL232 sending (MVT100 receiving)
	Black	TTL232 ground wire

8.2 Wiring Diagram

8.2.1 Power Cable/Ground Wire (Pin 1/2)

Connect the power cable (red) and ground wire (black) to the positive and negative electrodes of the vehicle battery respectively.

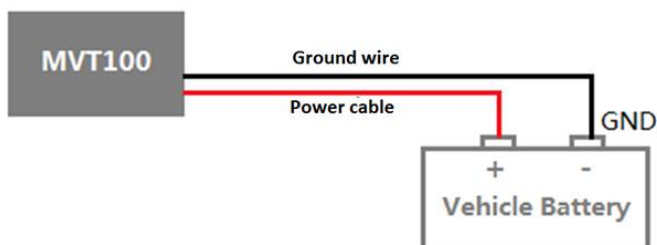

8.2.2 Digital Input 1 (Pin 4, Negative Trigger/SOS Button)

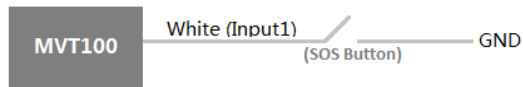

8.2.3 Digital Input 2 (Pin 5, Positive Trigger)

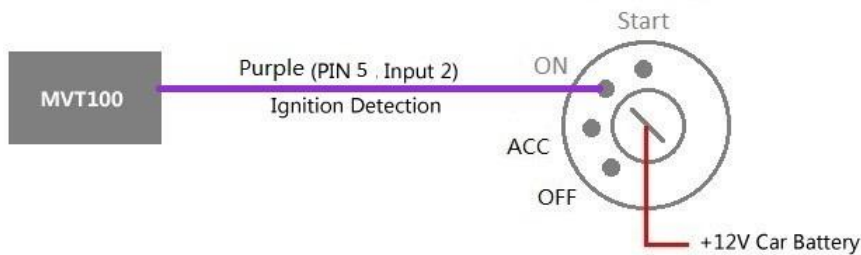

8.2.4 Output (Pin 7)

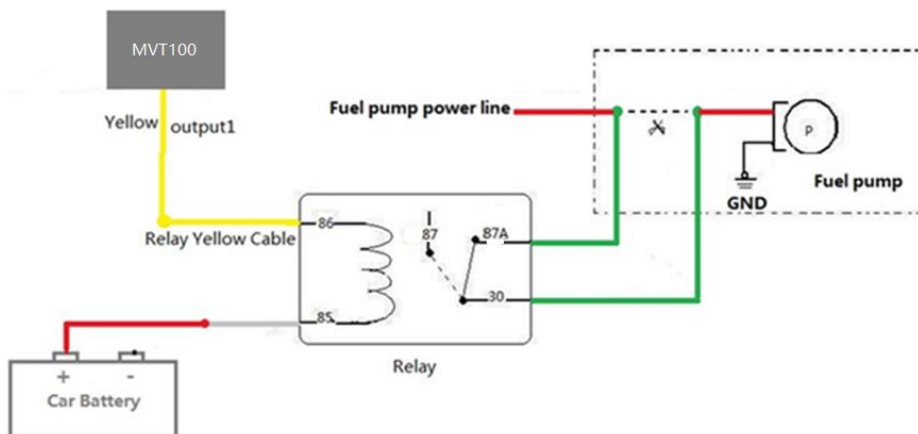

8.2.5 Voltage Formula for the Built-in Battery and External Power Supply

Built-in battery input voltage = $(AD4 \times 3.3 \times 2)/4096$

Battery percentage = $[(AD4 - 2114) \times 100/492] \times 100\%$

External power supply input voltage = $AD5/4096 \times 3.3 \times 16$

8.2.6 Analog Input (Pin 6)

The AD analog input can connect to a sensor whose output voltage ranges from 0 V to 6.6 V.

AD analog voltage = $(AD1 \times 3.3 \times 2)/4096$

8.3 Mounting the MVT100

Use any of the following methods to mount the MVT100:

- 3M sticker

- Screw
- Built-in super magnet



If you have any questions, do not hesitate to email us at info@meitrack.com.